



THE HUBSAN FPV X4

2.4GHZ RC SERIES 4 CHANNEL

HI07D X4 FPV MINI QUADCOPTER



ITEM NO.: HI07D
FLIP TIPS SEE PAGE 17-18

CATALOG

INTRODUCTION	02
SAFETY NOTES	02
SAFETY CHECK BEFORE FLYING	04
CHARGING THE LI-PO BATTERY	05
TRANSMITTER	06
CAMERA RECORDING	11
FLY THE X4	12
ADVANCED PERFORMANCE SETUP	16
REPLACING PROPELLERS	19
EXPLODED VIEW	22
H107D TROUBLESHOOTING.....	23
SPARE PART CHART	27

1 INTRODUCTION

Thank you for buying HUBSAN products. The X4 quadcopter is designed as an easy-to-use, full-featured RC model capable of hovering, fast forward, and aerobatic flight maneuvers. Please read the manual carefully and follow all instructions in it. Be sure to retain the manual for future reference, routine maintenance, and tuning.

2 SAFETY NOTES

2.1 Important Notes

This RC quadcopter is not a toy.

Any improper use of this product will result in serious injury. Be aware of your personal safety, safety of others and your surrounding environment.

We recommend beginners learn to fly with more experienced pilots playing nearby before attempting to fly the X4 for the first time.

2.2 Caution

The X4 quadcopter has parts that move at high speed, which poses a certain degree of danger.

Choose a wide open space without obstacles. Do not operate the X4 near buildings, crowds of people, high voltage cables, or trees to ensure the safety of yourself, others and your model.

Improper operation may cause damage to people and property.

2.3 LiPo Battery Safety Notes

The X4 is powered by a Lithium-Polymer (LiPo) battery.

To avoid risk of fire or damage, never recharge your battery while it is inserted in the X4.

If you do not plan to fly the X4 for a week or more, store the battery approximately 50% charged to maintain battery performance and life.



SAFETY ADVISORY NOTICE

Lithium-Polymer (LiPo) Batteries

LiPo batteries are different from conventional batteries in that their chemical contents are encased in a relatively lightweight foil packaging. This has the advantage of significantly reducing their weight, but does make them more susceptible to damage if roughly or inappropriately handled. As with all batteries, there is a risk of fire or explosion if safety practices are ignored:

- ☑ Charge and store LiPo batteries in a location where a battery fire or explosion (including smoke hazard) will not endanger life or property.
- ☑ Keep LiPo batteries away from children and animals.
- ☑ Never charge the LiPo battery that has ballooned or swelled .
- ☑ Never charge the LiPo battery that has been punctured or damaged.
- ☑ After a crash, inspect the battery pack for the sign of damage. Discard in accordance with your country's recycling laws.
- ☑ Never charge the LiPo battery in a moving vehicle.
- ☑ Never overcharge the LiPo battery.
- ☑ Never leave the LiPo battery unattended during recharging.
- ☑ Do not charge LiPo batteries near flammable materials or liquids.
- ☑ Ensure that charging leads are connected correctly. Reverse polarity charging can lead to battery damage or a fire or explosion.
- ☑ Have a suitable fire extinguisher (electrical type) OR a large bucket of dry sand near the charging area . Do not try to extinguish electrical (LiPo) battery fires with water.
- ☑ Reduce risks from fire/explosion by storing and charging LiPo batteries inside a suitable container.
- ☑ Protect your LiPo battery from accidental damage during storage and transportation. (Do not put battery packs in pockets or bags where they can short circuit or can come into contact with sharp or metallic objects.).
- ☑ If your LiPo battery is subjected to a shock (such as a crash), place it in a metal container and observe for signs of swelling or heating for at least 30 minutes.
- ☑ Do not attempt to disassemble or modify or repair the LiPo battery.

2.4 Prevent Moisture

The X4 contains many precision electrical components.

Store the battery and the X4 in a dry area at room temperature. Exposure to water or moisture may cause malfunction resulting in loss of responsiveness, or a crash.

2.5 Proper Operation

For safety only use the included HUBSAN spare parts for replacement.

2.6 Always Be Aware of the Rotating Blades

When in operation, the main and tail rotor blades will be spinning at high speed. The blades are capable of inflicting serious body injury or property damage.

Be careful to keep your body and loose clothing away from the blades. Never take your eyes off the X4 or leave it unattended while it is turned on. Stop operating immediately if the X4 flies out of your view. Once landed, immediately turn off the X4 and transmitter.

2.7 Avoid Flying Alone

Beginners should avoid flying alone when learning flight skills. We recommend flying with an experienced pilot nearby in case you need help.

3 SAFETY CHECK BEFORE FLYING

CAREFULLY INSPECT THE X4 BEFORE EVERY FLIGHT

- Before operation, check the batteries of the transmitter and X4 are charged for the flight.
- Before turning on the transmitter, check that the throttle stick is pulled completely backward (down position).
- Carefully check rotor blades and rotor holders. Broken parts will pose risk of injury and hazard.
- Check the battery and power plug are securely fastened. Severe vibration during flight may detach the plug and result in loss of control.
- When turning on the unit, always turn on the transmitter first, and then turn on the X4. To power off, always turn off the X4 first and then the transmitter. Improper procedure may cause loss of control of the quadcopter.

4 CHARGING THE LI-PO BATTERY

4.1 3.7V 380mAh LiPo Battery

4.1.1 Take out the battery from the bottom of the X4.

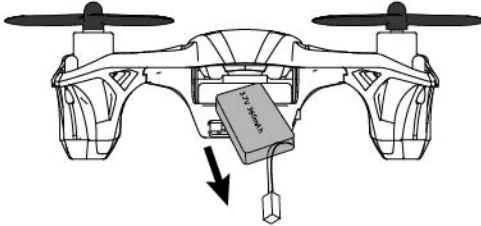

4.1.2 Connect the battery with USB charger, then connect the USB charger to a computer or other USB connector, such as a smartphone charger. The LED lights up while charging and turns off when charging is complete. The voltage of the USB is $+5\pm 0.5V$.

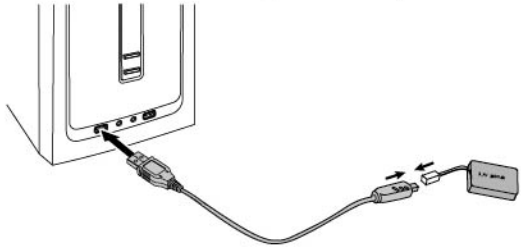

4.2 Safety Advisory Notice

Always partially charge your LiPo battery before storage. LiPo batteries retain the power over a reasonable period; it is not normally necessary to recharge stored LiPo batteries unless stored for periods longer than 3-6 months.

If your LiPo battery has been over-discharged, it will not be possible to recharge it again.



LiPo Battery Disposal & Recycling



Lithium-Polymer(LiPo) batteries must not be placed in with household trash. Please contact your environmental or waste agency or the supplier of your model for local regulations and the location of your nearest LiPo battery recycling center.

5 TRANSMITTER

5.1 Identification and Functions of the Main Menu

Main Menu

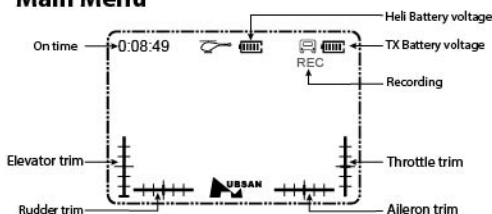

MODE 1

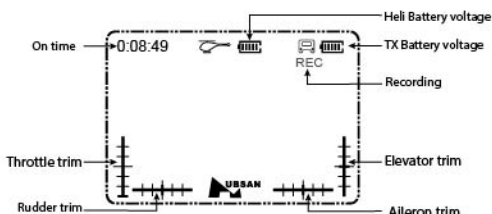

MODE 2

FPV TRANSMITTER

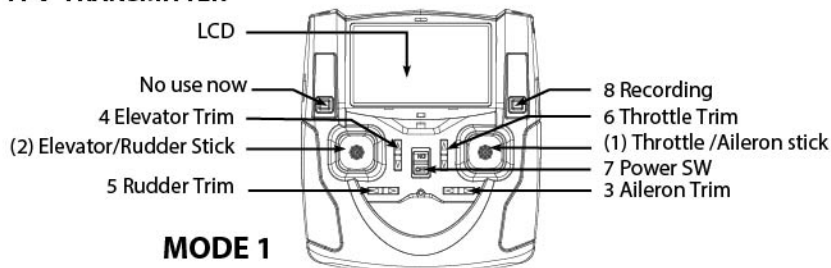

MODE 1

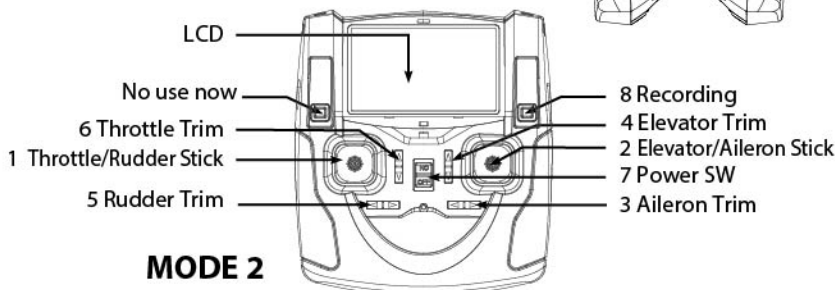
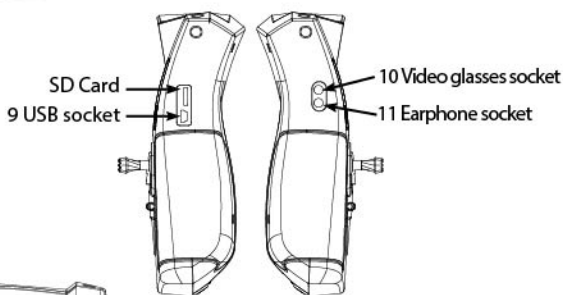

MODE 2

Input Key Function

S/N	Mode/ Control	Function
(1)	MODE 1 Throttle /Aileron Stick	Move the stick forward or backward to increase or decrease speed . Move the stick left or right to make the quadcopter roll left or right to initiate a banked turn.
(2)	MODE 1 Elevator/Rudder Stick	Move the stick forward or backward to make the quadcopter nose point up or down. Move the stick left or right to make the quadcopter yaw left or right.
1	MODE 2 Throttle/Rudder Stick	Move the stick forward or backward to make the quadcopter ascend or descend. Move the stick left or right to rotate the quadcopter's fuselage left or right.
2	MODE 2 Elevator/Aileron Stick	Move the stick forward or backward to make the quadcopter move forward or backward. Move the stick left or right to make the quadcopter drift sideways left or right.
3	Aileron Trim	Aileron trim adjusts for left and right drift.
4	Elevator Trim	Elevator trim adjusts for forward and backward drift.
5	Rudder Trim	Rudder trim adjusts for drift of left and right rotation or yaw.
6	Throttle Trim	Throttle trim normally left at neutral. The lower trim turns LEDs on and off.
7	Power Switch	Push to ON to turn on the transmitter. Push to OFF to turn off.
8	Recording	The new model can support for video recording. Press the Recording button for 1 second to confirm or exit.
9	USB socket	Only for engineer to upgrade the software, please do not use it to connect computer
10	Video glasses socket	Connect Hubsan H510 video glasses, which not included and need purchase
11	Earphone socket	Connect earphone after we upgrade the transmitter, now there is no voice transmission

5.2 Transmitter Stick Calibration

Mode 2: Push both sticks to the upper left position and hold, then power on the transmitter. Rotate both sticks twice. Hold down any trim until the LED on the transmitter blinks red, indicating successful calibration.

Mode 1: Push the left stick to the upper left position and right stick to the upper right position and hold, then power on the transmitter. Rotate both sticks twice. Hold down any trim until the LED on the transmitter blinks red, indicating successful calibration.

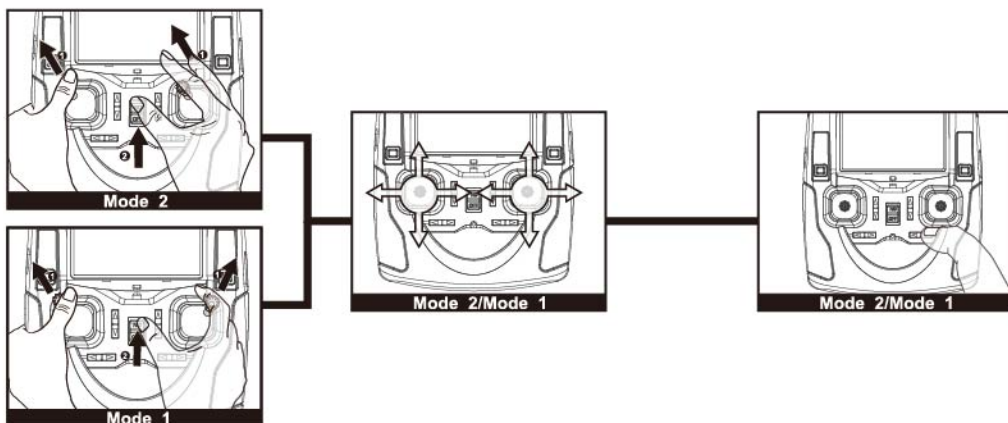

5.3 Transmitter Battery Installation

Notice: Do not mix old and new batteries.

Do not mix different types of batteries.

Do not charge non-rechargeable batteries.

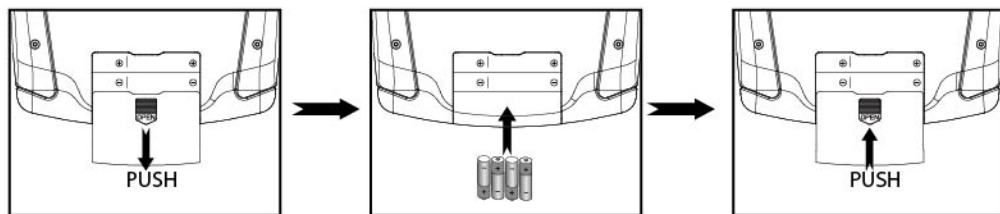

Remove the cover

Install 4 x AAA batteries
according to the correct polarities

Replace cover

Notice:

1. The video will stop when the TX battery is low.
2. When the SD card is full, it can't record anymore and the screen will display "SD Full".
3. It is best to use a 4G+, and class 4+ SD card. Format in the transmitter before use.
4. When the power on the TX is low, the red LED will blink quickly and the LCD screen will turn black. The TX and X4 will not bind if the batteries are low. Please replace with new batteries.
5. If the batteries in the TX are running low whilst flying the X4, you will still have control. Please land the X4 and then replace batteries in the TX.
6. The TX can only use 4XAA batteries or NI-MH AA batteries, other batteries will damage the TX.

5.4 Frequency selectable 5.8Ghz

Your transmitter will automatically find the best frequency to ensure the quality live video transmission. in case there is any interference in your location, you can change the setting from the range 5.725 to 5.945 Ghz to get longer range and better video transmission.

Press down the ELEVATOR stick for 1 second to enter setting status, move the stick up/down to choose 5.8G FREQUENCY, push the ELEVATOR stick to the right and move the stick up/down to select the frequency set, set what frequency you need by pushing the stick left/right, exit this setting as the displayed arrows show. Or hold down the ELEVATOR stick for 2 seconds to exit.

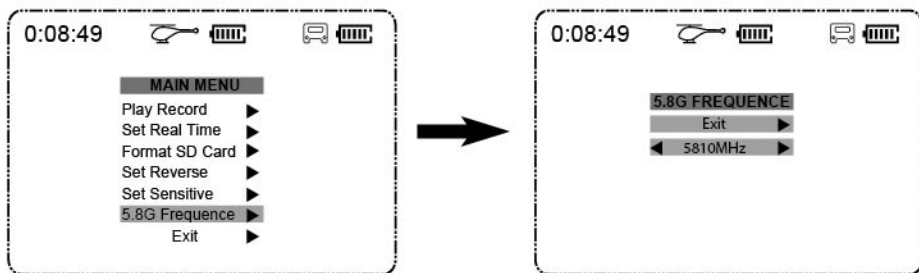

5.5 Play Record

Your transmitter can play the video recording that you saved.

Press down the ELEVATOR stick for 1 second to enter setting status, move the stick up/down to choose PLAY RECORD, push the ELEVATOR stick to the right, push right/left to choose NEXT/STOP. Hold down the ELEVATOR stick for 2 seconds to exit.

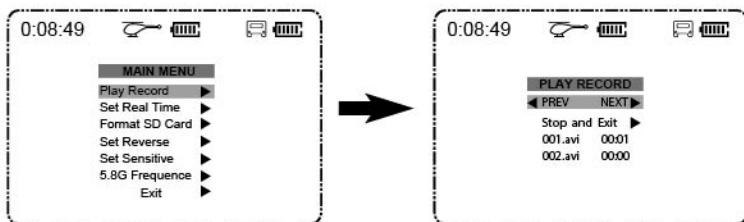

5.6 Set Real Time

Your transmitter can set a real time clock. Once you set the time it can display the real time in your time zone.

Press down the ELEVATOR stick for 1 second to enter setting status, move the stick up/down to choose **SET REAL TIME**, push the ELEVATOR stick to the right, move it up/down to choose and push right/left to set the time. After finishing, exit by pushing the ELEVATOR stick to the left. Hold down the ELEVATOR stick for 2 seconds to exit.

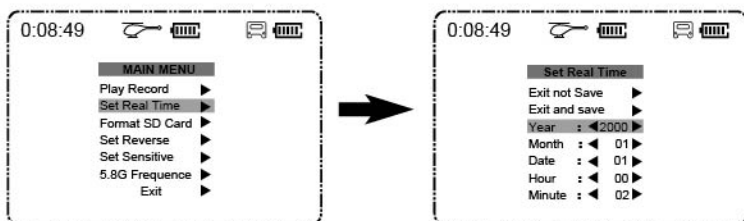

5.7 Format SD Card

Insert your SD card into the transmitter. The transmitter can format your SD card.

Press down the ELEVATOR stick for 1 second to enter setting status, move the stick up/down to choose **FORMAT SD CARD**, push the ELEVATOR stick to the right, move it up/down to choose and push right to confirm or exit. Hold down the ELEVATOR stick for 2 seconds to exit. **WARNING!** **ALWAYS FORMAT AND ACTIVATE CAMERA RECORDING BEFORE FLIGHT!**

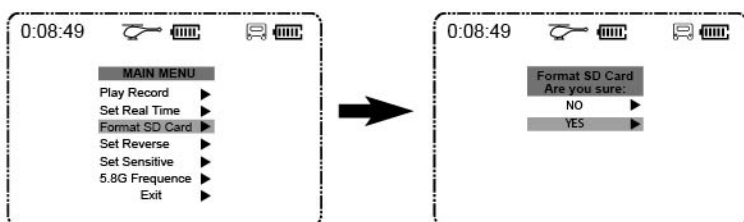

6 CAMERA RECORDING

Note:

Always turn OFF the power of the transmitter before inserting or removing the SD card. Always stop the video recording function and power off the battery firstly, and then you can take out the SD card.

WARNING! ALWAYS FORMAT AND ACTIVATE CAMERA RECORDING BEFORE FLIGHT!

6.1 Insert the SD card

Note: Carefully and properly orient the SD card for insertion in the TX. (See the picture to the right) Avoid removing the SD card and re-inserting again too quickly otherwise the recording module will not work properly

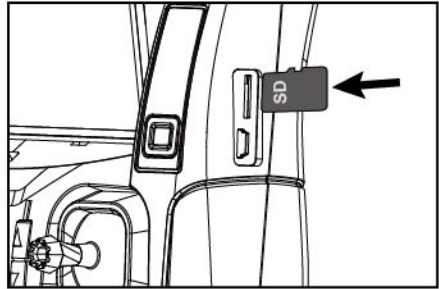

6.2 The screen will display REC in red and blinking when recording is started. (See the right picture)

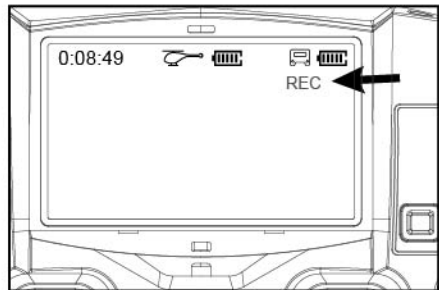

6.3 Start/Stop recording using the remote. **WARNING!** First activate the camera before flight in order to make sure the SD card is formatted. Formatting while in flight will result in loss of control.

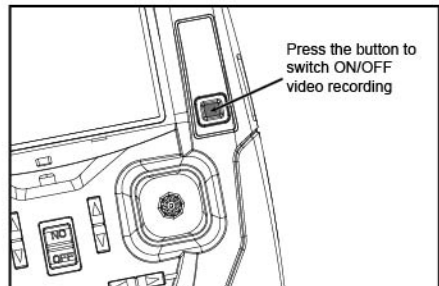

7 FLY THE X4

7.1 Power-On Safety Mode

Your X4's flight controller is designed with a Power-On safety feature that ensures that the X4's motor will not start unless it detects a suitable control signal when the LiPo battery is connected.

7.1.1 Make sure the throttle stick is in the full down position.

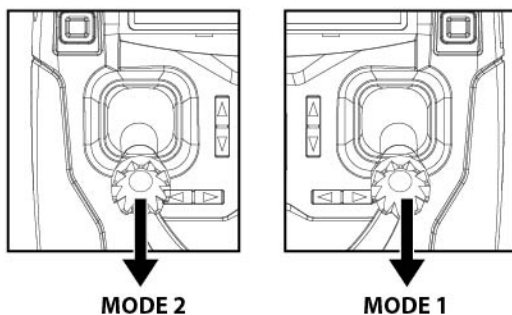

7.1.2 Power on the transmitter and the red LED will blink. Do not move any other stick or trim before the transmitter and X4 finish pairing, or the X4 will drift. The transmitter LED will turn green after pairing is successfully completed.

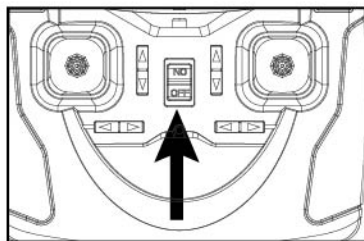

7.1.3 Connect the battery plug with correct polarity.

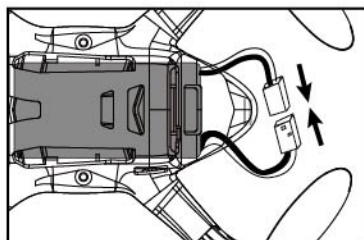

7.1.4 Insert the battery into the bottom of your X4. Make sure the battery and wires are pushed into the end of the battery compartment, so they will not negatively affect the center of gravity and cause unstable flight. **Twist the wires and squeeze them into the notched holder as shown, to prevent shaking when flying.**

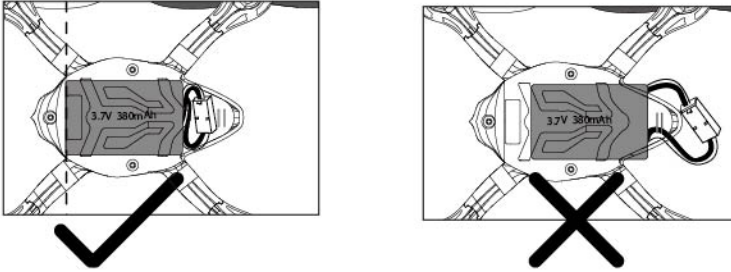

Always disconnect the X4 battery plug after turning off the transmitter when you stop flying.

7.1.5 LED Indications

After a “beep”, the red LED on the transmitter turns green, and the 6 lights on the X4 light steadily, indicating successful pairing. Press the lower throttle trim for about 2 seconds to turn the LEDs on or off. **NOTE: The LEDs will automatically blink when the quadcopter battery power is low or the pairing has failed.**

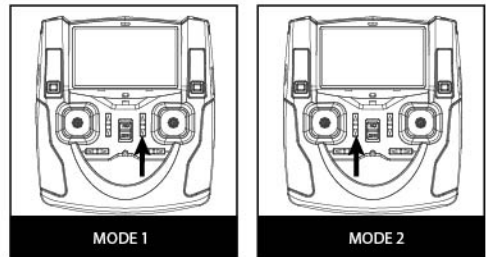
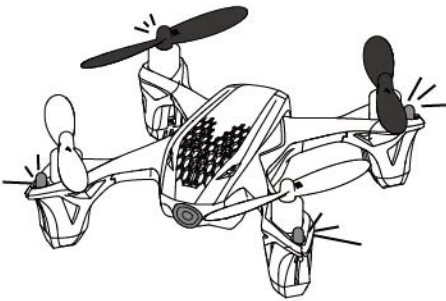

First Pilot View(FPV) Instructions:

For those just starting FPV with the Hubsan H107D please start **S-L-O-W-L-Y** and use the following guidance:

1. Learn how to fly the X4 and maintain control both indoors and outdoors at an altitude no higher than 10 feet before you advance to FPV flight and higher altitudes. A large part of being successful in FPV is training your fingers and brain to know how the model will respond with your inputs so you can predetermine your stick movements. It is very different to look at an LCD or goggles and

determine hover, altitude and speed. You will need to visually correlate and remember how the model reacts with stick movements and also the differences of those movements when in no wind and windy conditions.

2. When flying indoors or outdoors allow for plenty of free space with no couches, tables, trees buildings or other objects that you might fly into. A large area with soft grass is a perfect outdoor area to learn to fly. An asphalt parking lot is a terrible place to learn to fly. It is recommended that you use a safety spotter for your FPV flights!
3. First learn to master hovering, then master flying a square or rectangular pattern by recognizing features that are picked out before you begin your FPV flight.
4. The X4 prop guard is excellent to use indoors if required for your personal skill level, but using outside is optional and less desirable in many cases. Most fliers will want to remove it in order to gain some flight performance. The reason is that any wind when using the prop guard will make it more difficult to fly especially during FPV. Despite the safety feature and protection when using some kind of prop guard, all multi-copters lose flight performance when prop guards are used and will perform much better without them. You should also adjust your rates a bit higher for outdoor flight to something like 70 for pitch and roll. The X4 default expert rate settings will be too high for most new fliers and even skilled fliers for FPV. So as a suggestion for practice just increase the beginner values to about 70 when you are ready for outdoor FPV flying.

7.2 Transmitter Sticks And X4 Control Responses

CAUTION: To avoid loss of control, always move the transmitter sticks slowly. Be aware that control inputs will reduce available lift. Be ready to use a little extra throttle to maintain height during maneuvers.

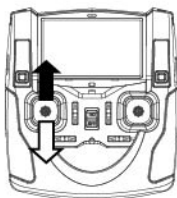

MODE 2

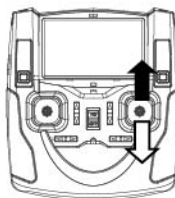

MODE 1

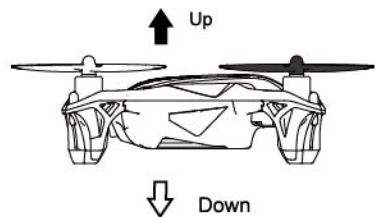

Throttle increases/decreases the flying height of your quadcopter.

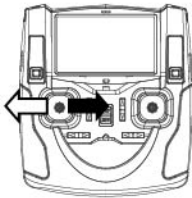

MODE 2

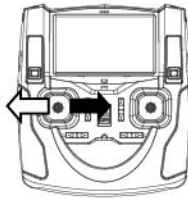

MODE 1

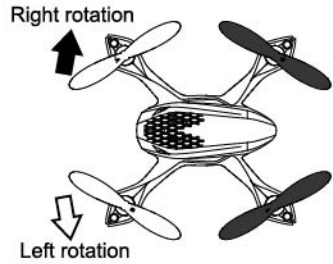

Rudder rotates your quadcopter's fuselage left or right.

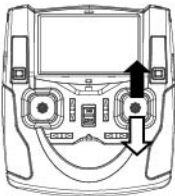

MODE 2

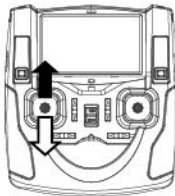

MODE 1

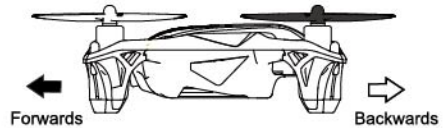

Elevator moves your quadcopter forward and backward.

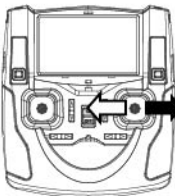

MODE 2

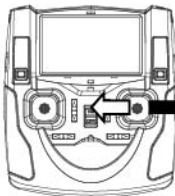

MODE 1

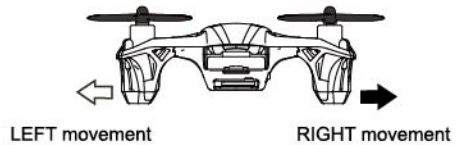

CAUTION: Controls will appear reversed when the model is flying towards you !

Aileron moves your quadcopter left and right.

8 ADVANCED PERFORMANCE SETUP

8.1 Reversing channel setup

If you would like to reverse any of the stick functions due to personal preference then follow the instructions below. Be aware that this will change the controls back to front.

Press down the ELEVATOR stick for 1 second to enter setting status, move the stick up/down to choose **SET REVERSE**, push the ELEVATOR stick to the right, move it up/down to choose and push right to confirm or exit. Hold down the ELEVATOR stick for 2 seconds to exit.

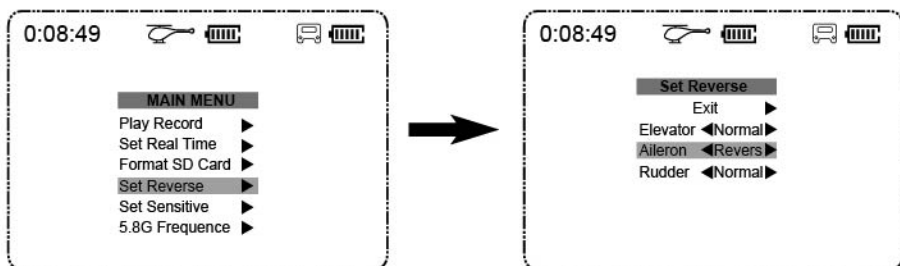

8.2 SENSITIVITY SET UP

If you would like to change the sensitivity of any of the stick functions then follow instructions below. A higher sensitivity value will enable larger/faster movement of the aircraft, while a lower sensitivity value will enable smaller/slower movement.

Press down the ELEVATOR stick for 1 second to enter setting status, move the stick up/down to choose **SET SENSITIVE**, push the ELEVATOR stick to the right, press the elevator/ aileron/ rudder trim to set the sensitivity. Push the elevator stick to the right to exit. Hold down the ELEVATOR stick for 2 seconds to exit the setup menu.

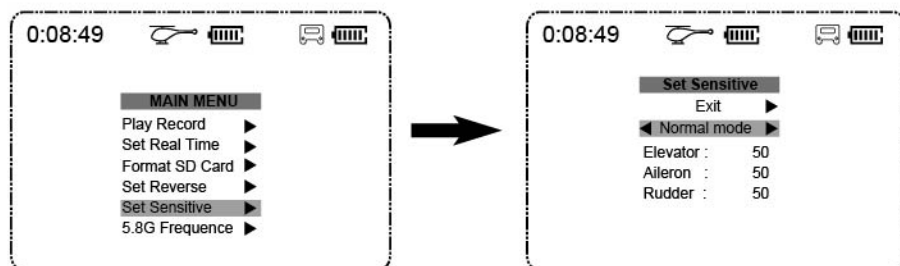

◆ EXPERT MODE

In expert mode, the sensitivity can be adjusted even further (up to 100) to give the user even more ability to manoeuvre the aircraft. Follow instructions below to switch this on/off.

Press down the ELEVATOR stick for 1 second to enter setting status, move the stick up/down to choose **SET SENSITIVE**, push the ELEVATOR stick to the right, choose NORMAL MODE, push the ELEVATOR stick to the right to enter into the expert mode, press the elevator/ aileron/ rudder trim to set the sensitivity. Push the ELEVATOR stick to the right to exit this set. Hold down the ELEVATOR stick for 2 seconds to exit.

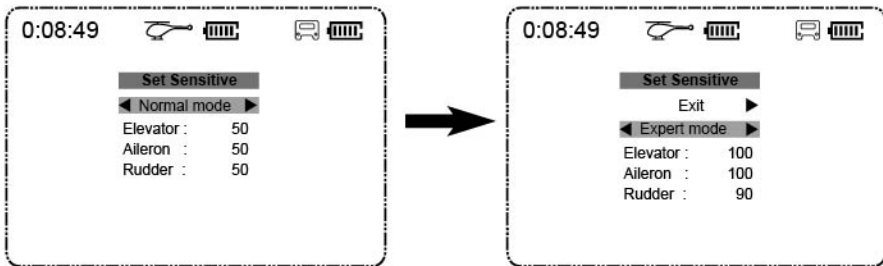

8.4 Aerial Flip Mode

The flip maneuver will only work in Expert Mode.

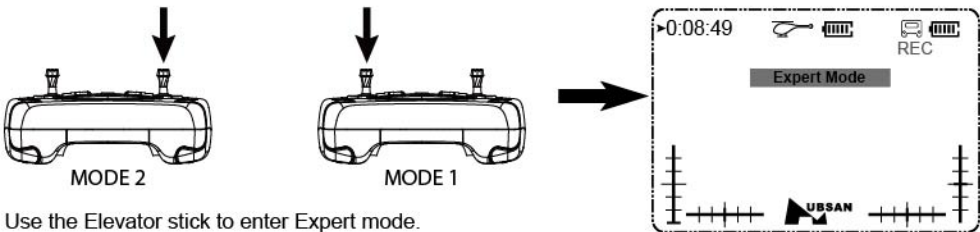

Use the Elevator stick to enter Expert mode.

Press the Throttle stick to enter Flip Mode, indicated by two "beeps".

Press the Throttle stick again to exit Flip Mode, indicated by one "beep".



For proper flip execution, make sure the X4 is close to level, within a 30° angle with the ground, and add throttle to climb before you perform a flip.

8.4.1 Left Flip

Push the Aileron stick fully to the right and then quickly push it fully to the left. Release the stick to the center position after the flip.

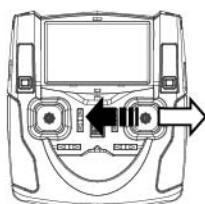

MODE 2

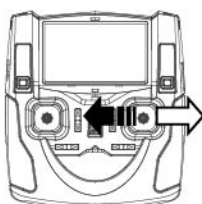

MODE 1

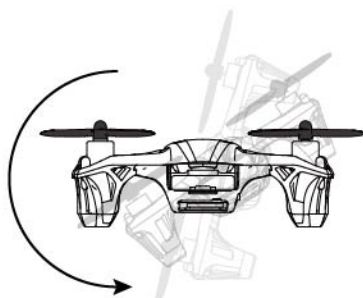

8.4.2 Right Flip

Push the Aileron stick fully to the left and then quickly push it fully to the right. Release the stick to the center after the flip.

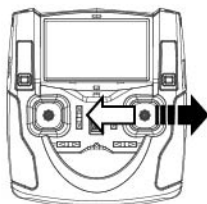

MODE 2

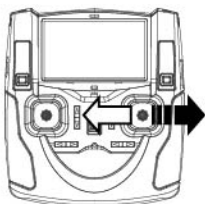

MODE 1

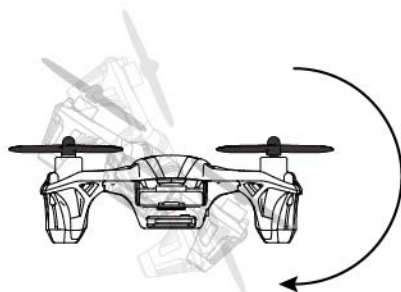

8.4.3 Forward Flip

Pull the Elevator stick backward and then quickly push it forward. Release the stick to the center after the flip.

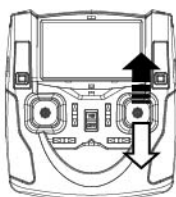

MODE 2

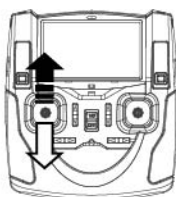

MODE 1

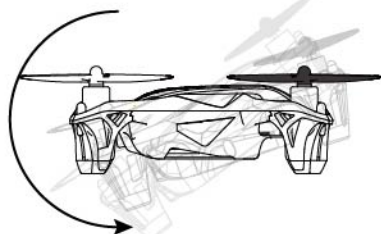

8.4.4 Backward Flip

Push the Elevator stick forward and then quickly pull it backward. Release the stick to the center after the flip.

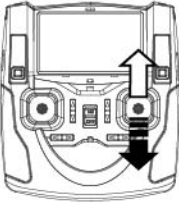

MODE 2

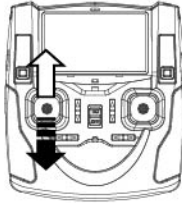

MODE 1

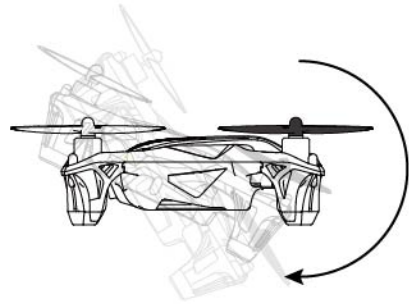

Note: when the X4 battery is low, performing flip is not possible.

9 REPLACING PROPELLERS

The X4's propellers are not identical. Each propeller is labeled with an A or B. When installing replacement propellers, be certain to install as shown below. The X4 will not fly, and will flip and crash if the propellers are not installed correctly.

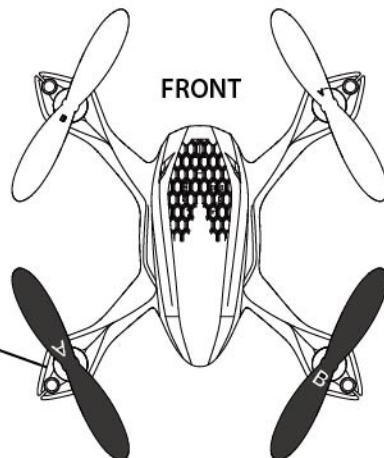
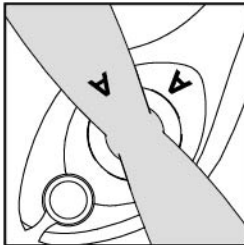

Remove Propellers: Hold the propeller, insert the U wrench under the propeller, pull up and the propeller will easily come off the motor shaft.

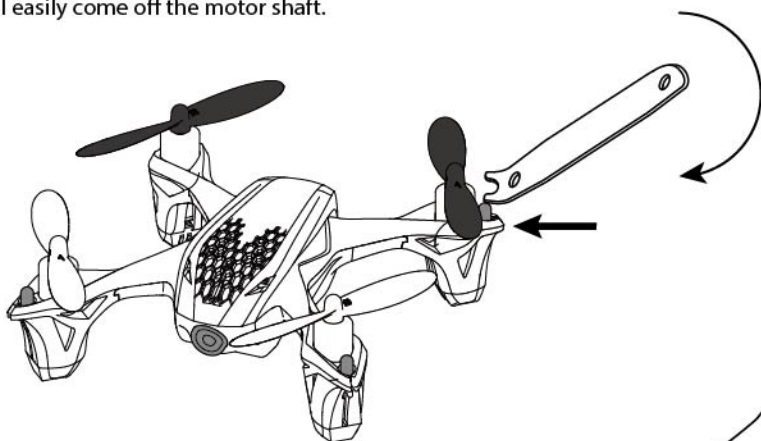

Install Propellers: Pinch the propeller hub, align the hole to the motor shaft, and press it straight down firmly but gently.

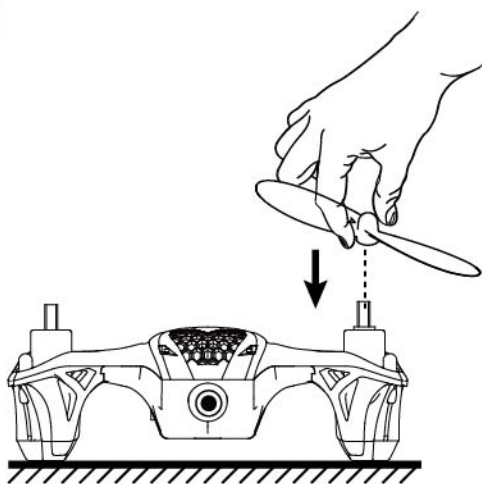

The propellers are dangerous when the quadcopter is flying. To avoid injury or damage, install the protection cover.

Note:

Remove the propellers. Position the cover's four holes with the motors. Press each of them onto the motors, then re-install the propellers in their correct positions on the X4 .

When removing the protection cover, remove the propellers first as in the above steps, and pinch the protection cover from each motor. After any crash landing, always check to make sure the protection cover is still on tight, and that the body, motors and propellers are not damaged.

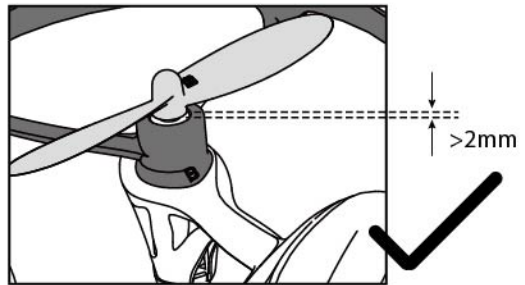
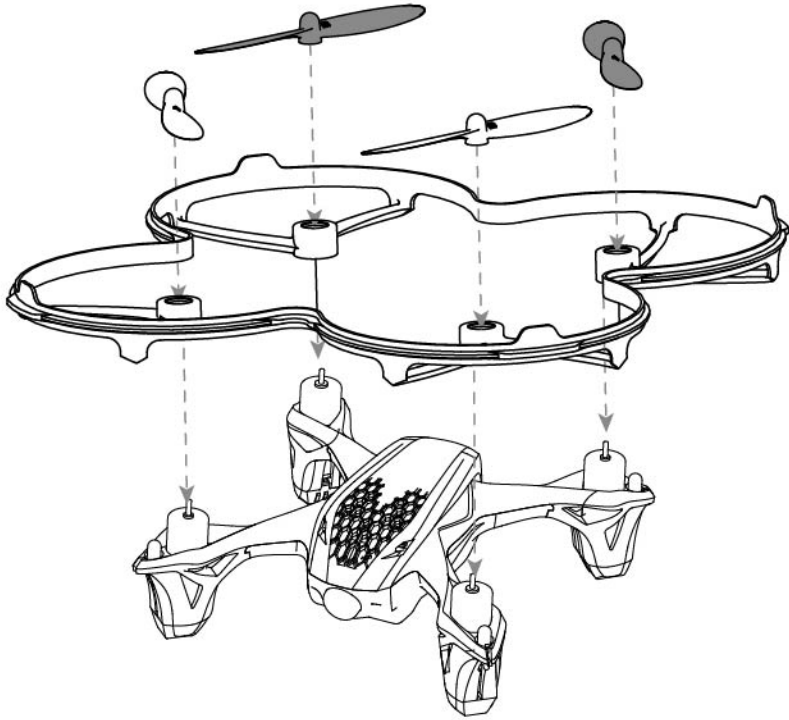

Attention: After a crash landing, the protection cover will loose and block the propellers, check and press back the four cover holes before flying again.

Exploded View

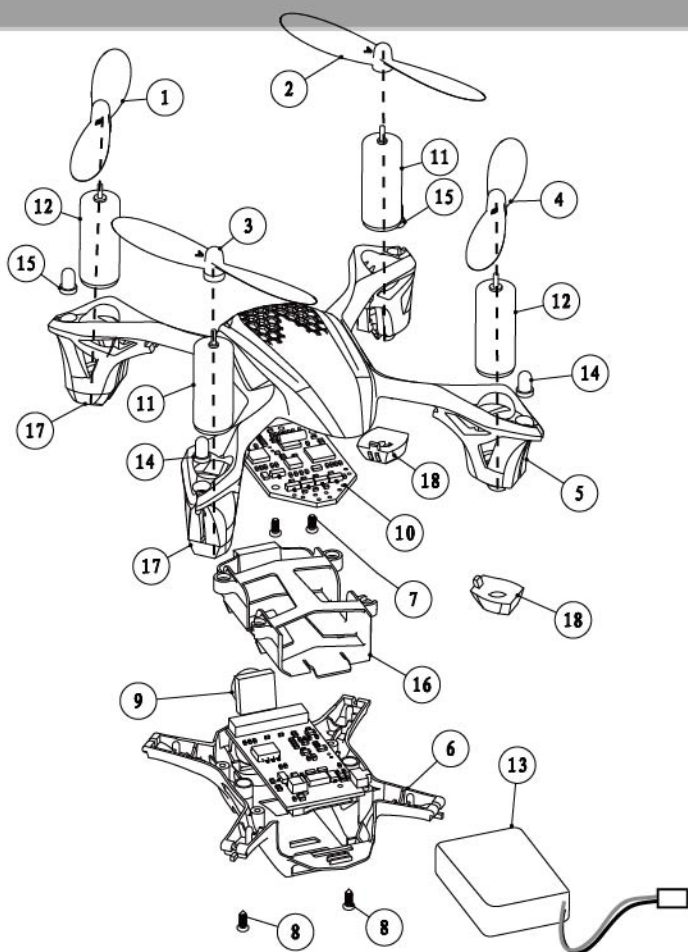

No	PART NAME	QTY	No	PART NAME	QTY
1	White blade B	1	10	FPV RX	1
2	White blade A	1	11	820 motor(clockwise)	2
3	Red blade A	1	12	820 motor(anticlockwise)	2
4	Red blade B	1	13	Li-po battery	1
5	Upper shell	1	14	LED(Red)	2
6	Lower shell	1	15	LED(Blue)	2
7	Screw(PB1.4*3)	2	16	Battery box	1
8	Screw(PA1.4*4)	2	17	Rubber feet-1	2
9	Camera PCB module	1	18	Rubber feet-2	2

1. Transmitter and X4 do not pair.

Throttle stick needs to be in the full down position. Make sure you do not move the transmitter sticks or trim during initial power-on.

2. Transmitter LED suddenly goes out.

Replace the AAA batteries in the transmitter.

3. Transmitter display is not showing the setting interface after holding down the throttle for 2 seconds.

The throttle stick needs to be in the full down position.

4. Gyro is not working well.

(1) Battery voltage is too low.

(2) Pair the X4 with the transmitter again.

(3) Land the X4 with the throttle stick in the full down position for 3 seconds and then take off again.

5. X4 won't perform flips.

(1) Press the Elevator stick to enter into Expert Mode.

(2) In Expert Mode, the sensitivity on each channel should be above 90%. You can program the sensitivity in the Setup Menu. See 8.4 on P17-18.

(3) Press the throttle stick to turn on flip function.

(4) LiPo power is too low. Recharge the X4.

6. Quadcopter is shaking and making noise.

Check that the motors, canopy, body and propellers are all properly positioned.

7. Switching between low and high rates on the transmitter is difficult.

Press the Elevator stick briefly to switch between the Expert Mode (transmitter LED flashes red and green) and Normal Mode (transmitter lights up green steadily). "Expert" will also appear at the center on the display.

8. Cannot take off.

(1) Make sure the propellers are installed correctly. The propellers are marked with "A" (clockwise) and "B" (counterclockwise). Refer to the Top View picture below for the correct orientation.

(2) Make sure that each motor is installed correctly. There are two different motors with different motor wire colors. Refer to the Bottom View picture below for the correct order.

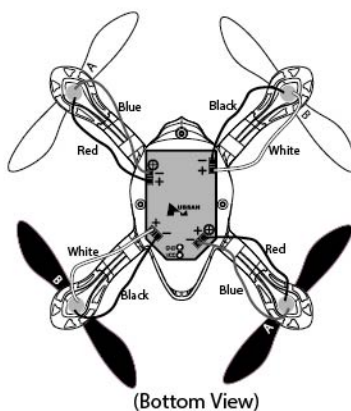
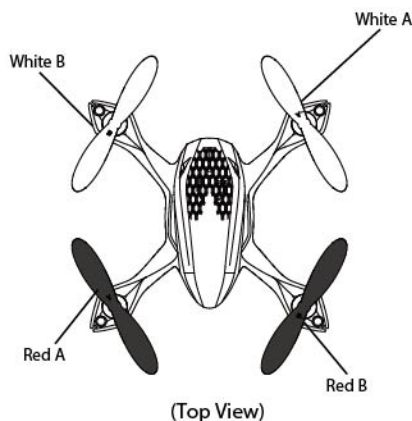

9. LED removal & installation.

Removal: Unscrew and remove the lower shell and the rubber feet. Then unsolder the red and yellow wires.

Installation: Solder the red wire on anode/positive (+), the yellow on cathode/negative (-), press the LED wires first, then the motor wires in the leg slots. Install the lower shell, then the rubber feet. You can determine the color of the LED lights by looking at the color of the LED wire insulation at the bottom of the LED lens: red color is red light, blue color is blue light.

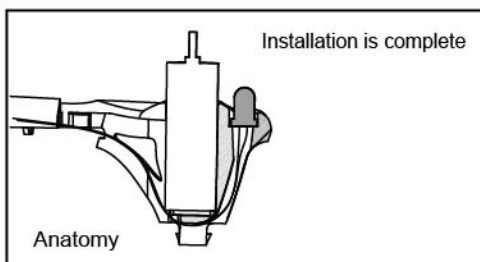
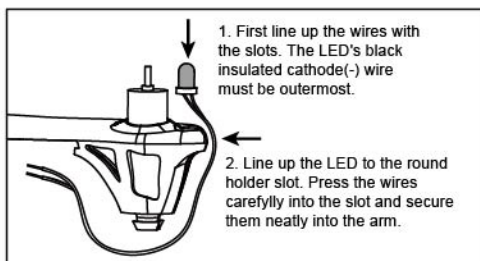
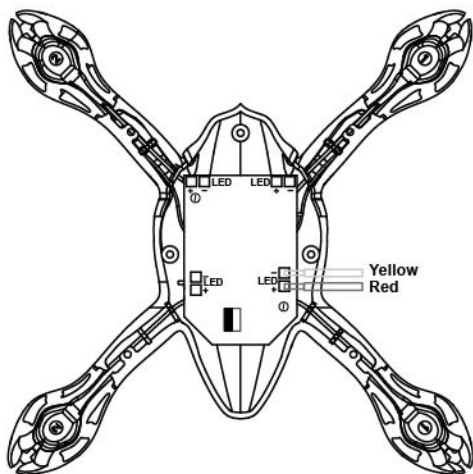

10. The motors do not spin freely after a crash.

Press the shaft down from the top of the propeller and motor to remove any objects, or replace the motor.

11. The arm of the X4 separates after a hard landing or crash.

This is specially designed to absorb impact from hard crashes. Simply force the arms to snap back into the joint position as shown.

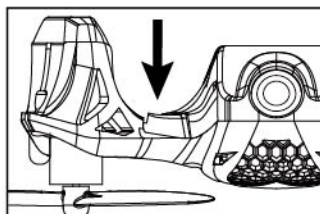

12. One or more motors stop working.

- (1) Replace the motor.
- (2) Resolder any broken motor connections.
- (3) Spin the propellers to see if it jammed the motors, make sure the propellers can spin normally.

13. The X4 always drifts to one direction.

Calibrate the accelerometer as follows:

1) Before calibrating the accelerometer, make sure that the propellers, motors and body are in good condition with the battery fully charged. Ensure that the battery and the cables are inserted into the battery compartment correctly (see the picture on P13 7.1.4). Pair the X4 and transmitter, then put the X4 in Expert Mode (see P17, 8.4).

2) Set both the aileron and elevator trim to the middle so that the LCD displays 50.



MODE 1

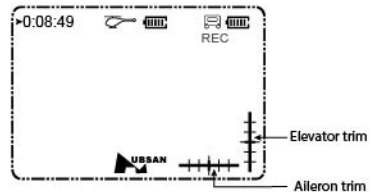

MODE 2

3) Hold the Throttle stick to the full down position and move the Rudder stick to the lower right position. Quickly move the Aileron stick to the left and right repeatedly until the two headlights blink, indicating successful calibration. This calibration will reduce excessive drifting when doing level yaw turns.

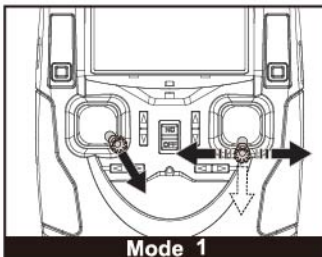

Mode 1

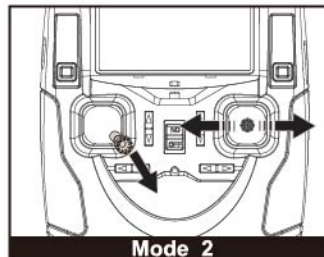

Mode 2

4) If the X4 still drifts to one side, add a few sheets of paper (the number of sheets will vary depending on the amount of drift) to the side of the X4 that drifts. The paper will help counterbalance and create a level offset angle.

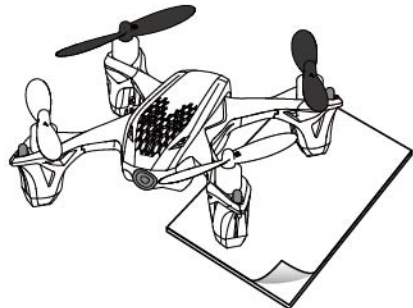

14. The Camera can't record

Press the button and the camera will start recording, when the recording is finished please press the button again to save it. If you don't want to save it please power off the TX. Please check the battery in both TX and X4, when the battery is low, it can't record.

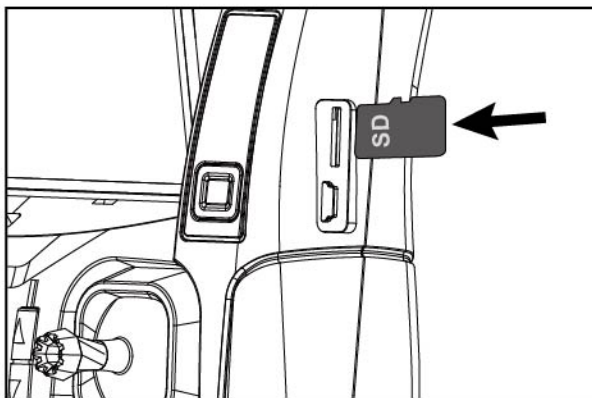

15. The video is not being saved to the SD card.

Always stop the video recording function and power off the battery first, after that you can take out the SD card.

Always turn off the power to the TX before inserting or removing the SD card. This allows the memory to be properly saved to the SD card.

16. The transmitter will not power on.

Check the battery connection.

If the transmitter battery power is low, you will need to replace with new AA batteries .

17. Why is it that when I record video, the SD card only recorded videos of 75MB total, but the file size when read on the computer remains only 175MB.

When the SD card is properly formatted in the TX, it will use special formatting that splits the continuous space in order to speedup recording and to have smooth playback. Therefore it shows a smaller file size when its properties are viewed on a computer. The SD card is full when the the LCD on the TX displays "Full".

Noted that when SD card is formatted in the TX, you must reformat it if you intend to use it in any other device. If you intend to use the SD card in another device, first save any files to your computer before formatting the card.

H107D SPARE PART CHART



H107D-A01
Body Shell

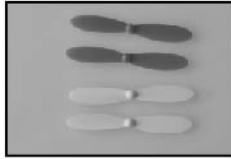

H107D-A06
Props

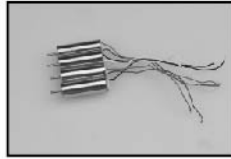

H107-A23
Motor



H107D-A03
X4 FPV RX

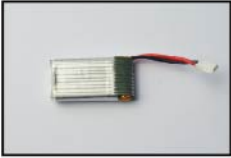

H107-A24
Battery



H107-A06
USB Charger



H107-A07
Screw Set



H107D-A05
Transmitter



H107D-A02
Rubber feet



H107-A11
U wrench



H107D-A19
M8 Protection Cover



H107-A13
T-Shirt

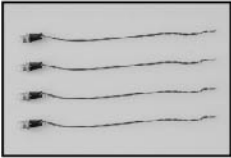

H107-A32
Blue LED

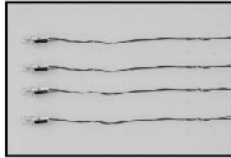

H107D-A33
Red LED



H107D-A04
Camera module
VGA 720*480



H107D-01
4*AA rechargeable
NI-MH battery (2000mAh)



H301F-15
SD Card



H107D-A07
crash pack

FCC Information

This equipment has been tested and found to comply with the limits for a Class B digital device, pursuant to Part 15 of the FCC Rules. These limits are designed to provide reasonable protection against harmful interference in a residential installation. This equipment generates, uses, and can radiate radio frequency energy and, if not installed and used in accordance with the instructions, may cause harmful interference to radio communications. However, there is no guarantee that interference will not occur in a particular installation. If this equipment does cause harmful interference to radio or television reception, which can be determined by turning the equipment off and on, the user is encouraged to try to correct the interference by one or more of the following measures:

- Reorient or relocate the receiving antenna.
- Increase the separation between the equipment and receiver.
- Connect the equipment into an outlet on a circuit different from that to which the receiver is connected.
- Consult the local dealer or an experienced radio/TV technician for help.

Changes or modifications not expressly approved by the party responsible for compliance could void the user's authority to operate the equipment.

This device complies with Part 15 of the FCC Rules. Operation is subject to the following two conditions: (1) this device may not cause harmful interference, and (2) this device must accept any interference received, including interference that may cause undesired operation.

Electrical and electronic equipment that are supplied with batteries (including internal batteries)

WEEE Directive & Product Disposal

At the end of its serviceable life, this product should not be treated as household or general waste. It should be handed over to the applicable collection point for the recycling of electrical and electronic equipment, or returned to the supplier for disposal.

Internal / Supplied Batteries.

This symbol on the battery indicates that the battery is to be collected separately.
This battery is designed for separate collection at an appropriate collection point.



THE HUBSAN X4

2.4GHZ RC SERIES 4 CHANNEL